



- ①. Designed for use with power integrations IC's ,Tiny switch family
- ②. Output voltage range from 5V to 12Vdc
- ③. 3000Vrms Isolation (Hi-Pot). Meets UL 1950, IEC950 Safety Standard

GENERAL ELECTRICAL SPECIFICATIONS

DIMENSION (mm)

EE19 H"TYPE

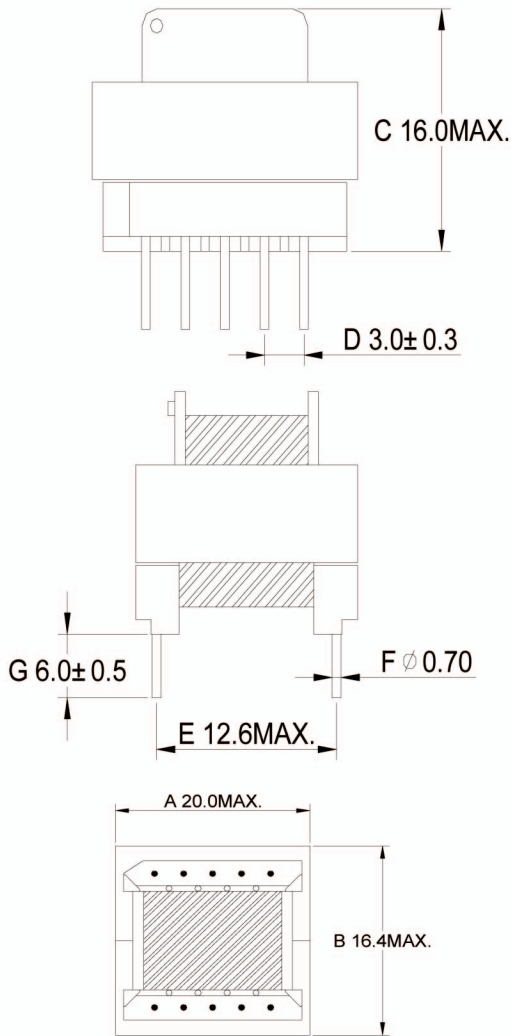

EE19 V"TYPE

